

PROSPAN

PROFESSIONAL SERIES • PNEUMATIC SHORING

Tabulated Data
for use with
Prospan Shoring Equipment

January 1, 2004

Prospan Manufacturing Co., Inc.

Rosemont, Illinois USA

1-888-413-8100

www.prospanshoring.com

GENERAL REQUIREMENTS:

Prior to using PROSPAN pneumatic struts, the Competent Person shall have a thorough knowledge of the requirements of OSHA 29 CFR 1926, Sub-Part P and ensure that all requirements have been met prior to the installation of the PROSPAN product. If, at any time, a worker is unclear as to the requirements of the OSHA standard or that of the PROSPAN product, activities shall cease and competent instruction sought. The PROSPAN product shall only be used by individuals trained in its use.

Users of this product must recognize that no protective system is appropriate for all applications. The Competent Person shall evaluate each and every situation and choose the appropriate level of protection accordingly.

INSTALLATION PROCEDURES:

- 1) The Competent Person, as defined in OSHA 29 CFR 1926 Sub-Part P, shall determine the soil type and method of protection.
- 2) The method of protection shall be in compliance with the Tabulated Data governing the use of the PROSPAN product.
- 3) Type C-60 soil is defined as C soil that will remain standing long enough to construct a protective system.
- 4) PROSPAN struts shall be installed precisely as stated in the Tabulated Data without exception.
- 5) All shoring equipment shall be inspected before each use to ensure it is in proper working order.
- 6) PROSPAN struts are to be positioned and pressurized from outside the trench or from within a shored area. Under no circumstances is a worker allowed to enter an *unshored (unprotected)* trench.
- 7) PROSPAN struts require an installation pressure of 115-220 psi and are required to be positioned within 15 degrees of horizontal (*and vertical*).
- 8) PROSPAN struts shall be installed in progression from the top of the trench to the bottom of the trench. Strut removal is to take place in progression from the bottom of the trench to the top of the trench. Back filling is recommended as struts are removed.
- 9) There shall be a minimum of two columns of shoring in all trenches where shoring is the sole method of protection.
- 10) The installation of additional shoring columns must be considered as the depth and length of the trench increases. This must be done to prevent an unsupported section of trench from collapsing and entering the protective system.
- 11) The spacing of shoring columns shall be in compliance with the MAXIMUM ALLOWABLE SPACING tables. For trenches with a depth greater than 8 feet, it is recommended that you shore a length of trench at least equal to its depth (i.e., a trench that is 20 feet long and 9 feet deep should have at least 9 feet of its length shored).
- 12) Prior to using the MAXIMUM ALLOWABLE SPACING tables, the Competent Person shall have a thorough knowledge of OSHA 29 CFR 1926 and the Tabulated Data governing the product.
- 13) PROSPAN struts may be used in conjunction with 2" x 10", #2 Douglas Fir timber uprights or the PROSPAN 12" Wale-Plates.
- 14) Wale-Plates may be positioned horizontally or vertically.
- 15) Plywood, timber uprights, and the 12" Wale-Plates shall bear directly on the trench walls. There shall be no gaps or voids.
- 16) Plywood sheeting is required in all trenches, regardless of depth, if sloughing or raveling is evident.
- 17) Sloughing and raveling is defined as the movement of soil around or between shoring elements.
- 18) Plywood sheeting is required in all C-60 trenches deeper than 10'.
- 19) Where plywood is required, it shall be 1-1/8" Douglas Fir or 14-ply white birch.
- 20) For conditions other than those covered by this tabulated data, an engineered system designed for the application is required.



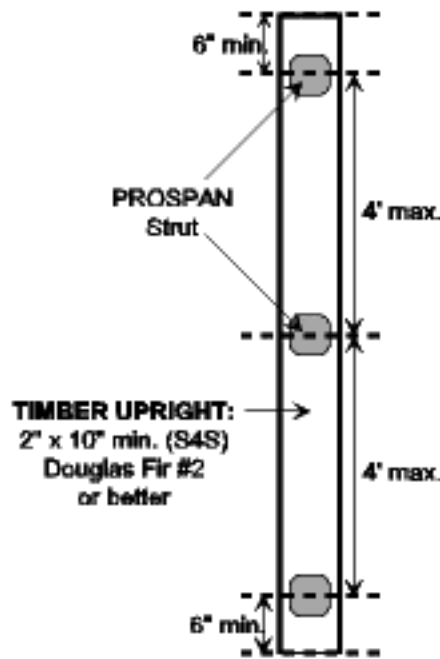

Figure-1: Allowable placement of struts on upright

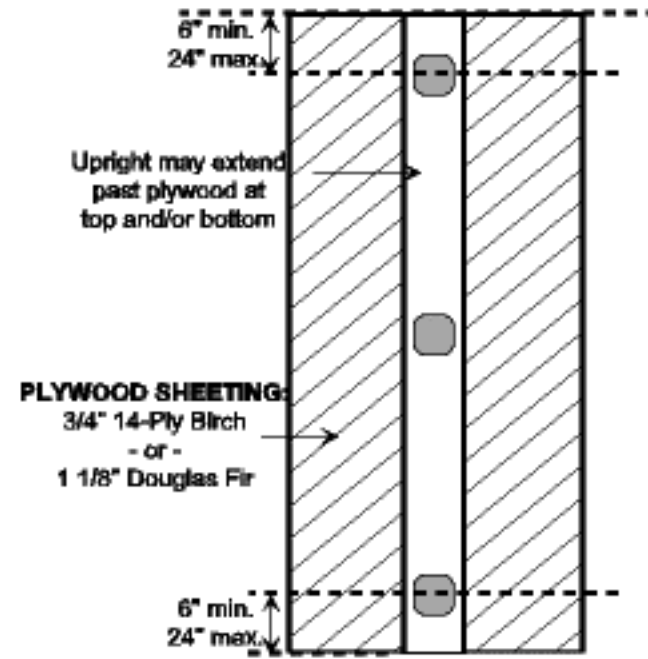

Figure-2: Allowable placement of uprights on plywood sheeting

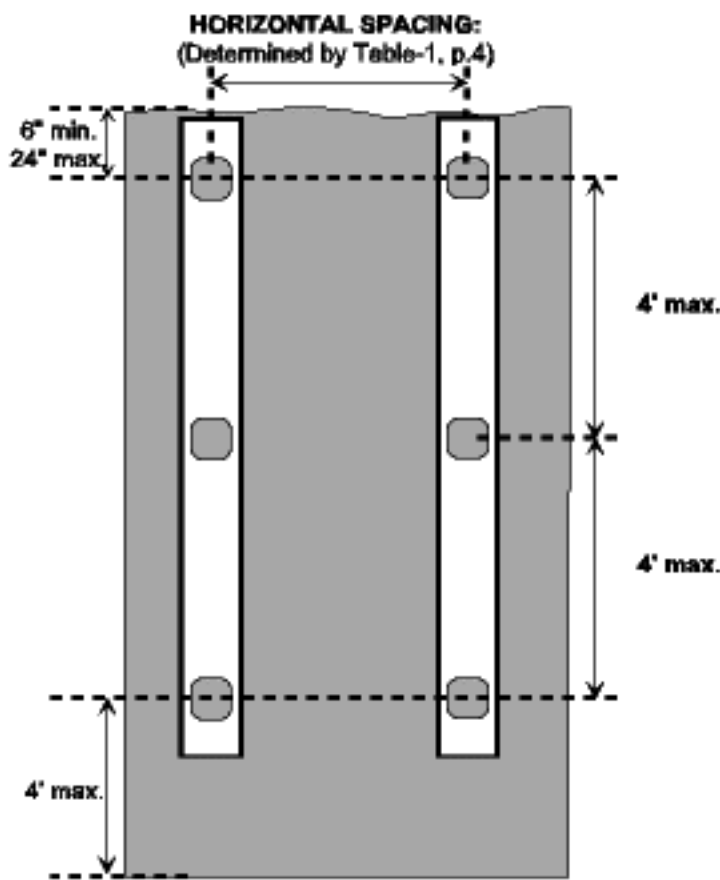

Figure-3: Allowable placement of uprights in trenches where plywood sheeting is not required

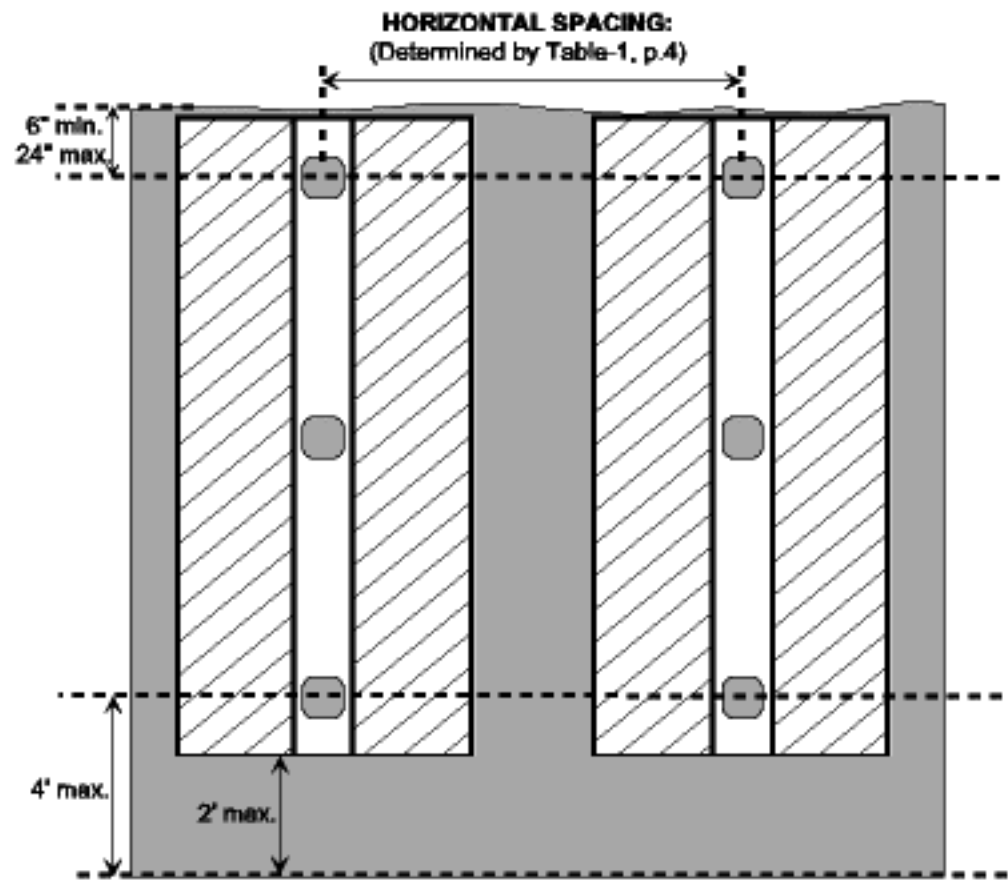

Figure-4: Allowable placement of uprights and sheeting in trenches where plywood sheeting is required

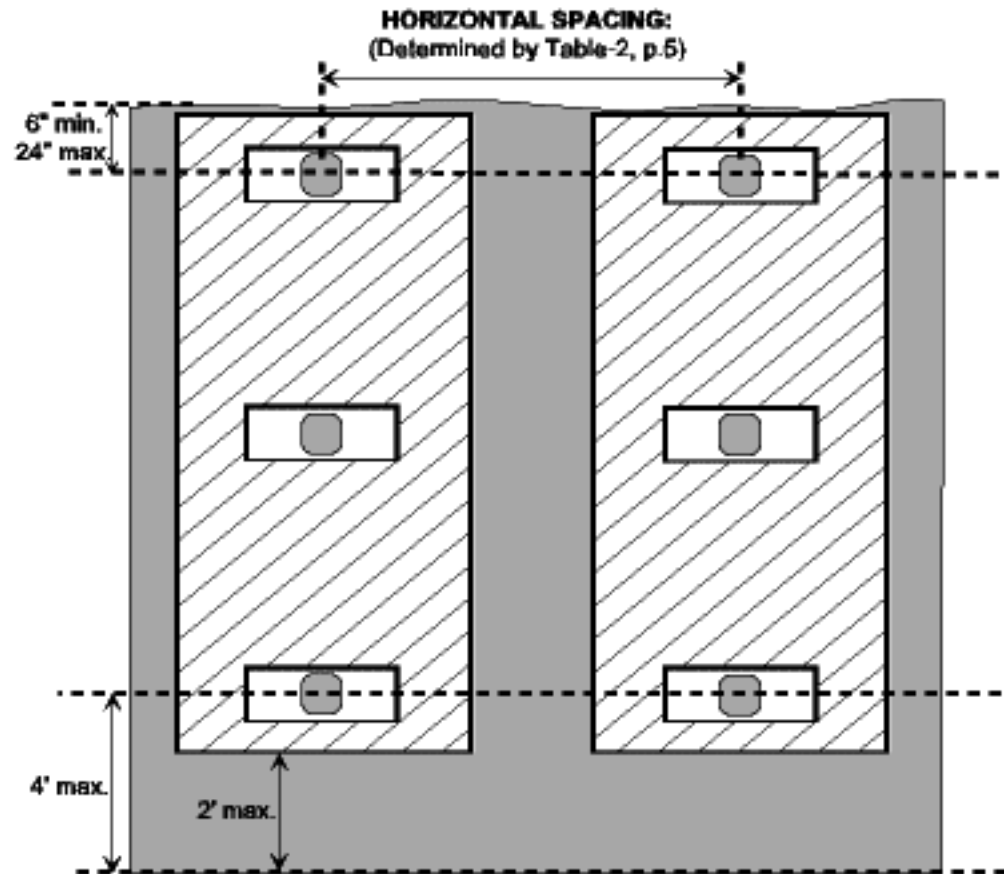
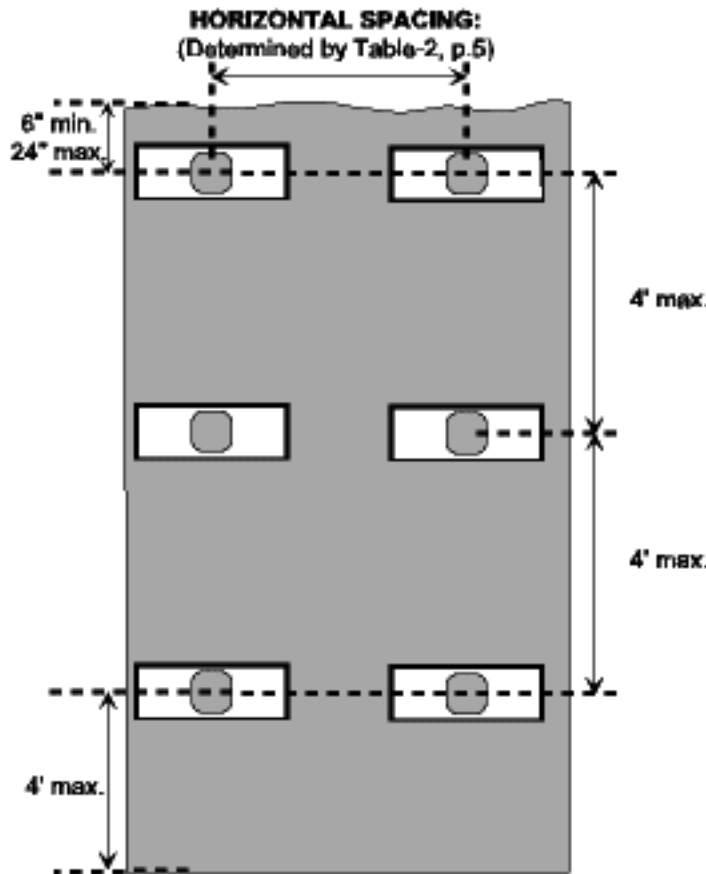

Figure-5: Allowable placement of wale plates in trenches where plywood sheeting is not required (horizontal orientation)

Figure-6: Allowable placement of wale plates and sheeting in trenches where plywood sheeting is required (horizontal orientation)

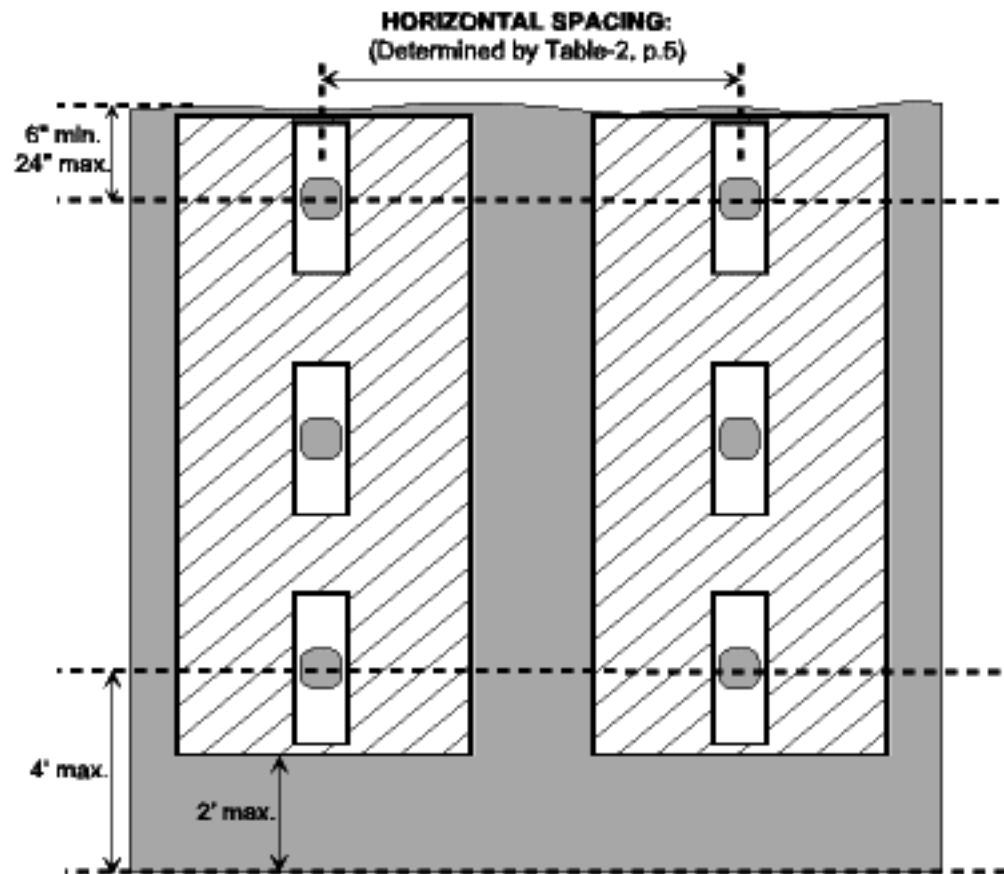
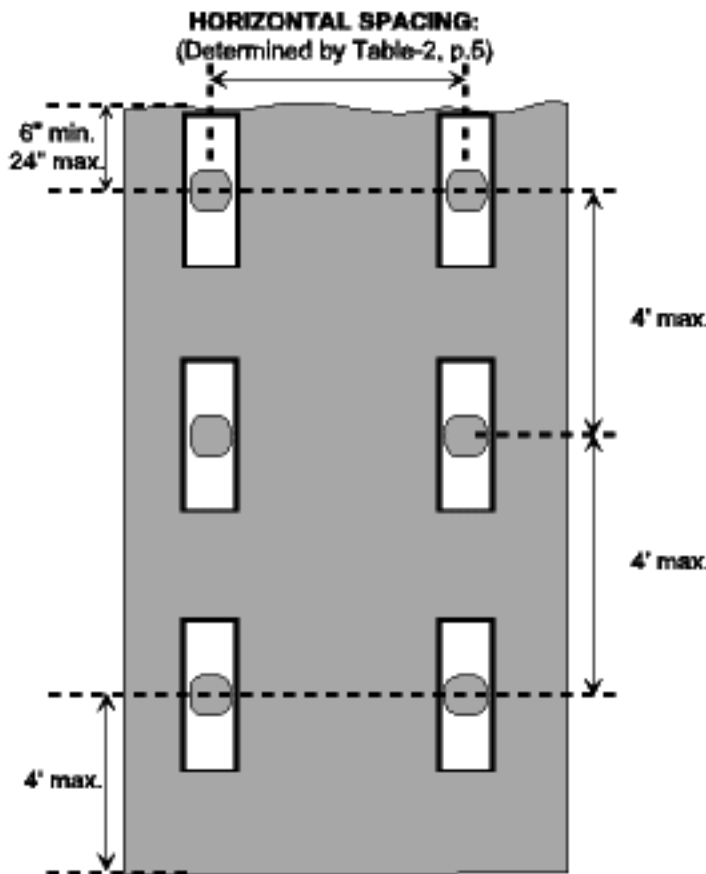

Figure-7: Allowable placement of wale plates in trenches where plywood sheeting is not required (vertical orientation)

Figure-8: Allowable placement of wale plates and sheeting in trenches where plywood sheeting is required (vertical orientation)

GENERAL REQUIREMENTS

- 1-All *Procedural Requirements* must be followed as specified on page-1.
- 2-All *Component Requirements* must be followed as specified on page-2.
- 3-Horizontal and vertical spacing shall not exceed the maximum allowable spacing specified in *Table-1* below.
- 4-Plywood sheeting is required in all soil classes if sloughing or raveling occurs and is required in class C-60 soils below the 10' depth.
- 5-There shall be a minimum of two columns of shoring in trenches up to 8' in depth. In trenches over 8' in depth, it is recommended that enough columns be placed to protect a length of trench equal to, or greater than the depth of the trench.
- 6-End wall support shall be required as specified on page-6.
- 7-Install pressure shall be 115-220 psi.

TABLE-1: MAXIMUM ALLOWABLE SPACING

SOIL TYPE	TRENCH DEPTH (FT)	TRENCH WIDTH (FT)	HORIZONTAL SPACING (FT)	VERTICAL SPACING (FT)	PLYWOOD SHEETING
A-25	4 to 10	to 6	8	4	*
		6 to 12	8	4	*
		12 to 16	5	4	*
	10 to 15	to 6	8	4	*
		6 to 12	8	4	*
		12 to 16	4	4	*
15 to 20	to 6	8	4	*	
	6 to 12	8	4	*	
	12 to 16	4	4	*	
B-45	4 to 10	to 6	8	4	*
		6 to 12	8	4	*
		12 to 16	4	4	*
	10 to 15	to 6	7	4	*
		6 to 12	6	4	*
		12 to 16	4	4	*
15 to 20	to 6	5	4	*	
	6 to 12	5	4	*	
	12 to 16	4	4	*	
C-60	4 to 10	to 6	8	4	*
		6 to 12	6	4	*
		12 to 16	4	4	*
	10 to 15	to 6	5	4	Required
		6 to 12	4	4	Required
		12 to 16	4	4	Required
15 to 20	to 6	4	4	Required	
	6 to 12	4	4	Required	
	12 to 16	—	—	—	

*Plywood Sheeting is required anytime sloughing or raveling occurs

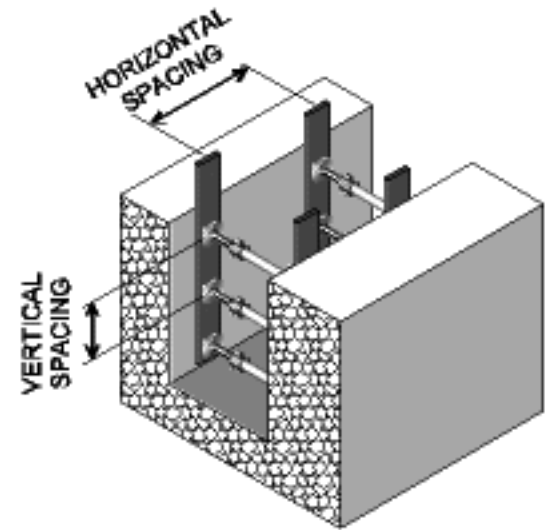

CLASS A & B
NO SLOUGHING
OR
RAVELING

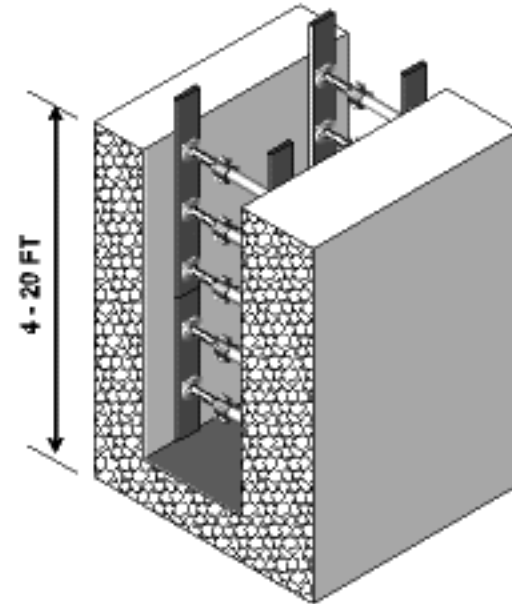

CLASS C-60
NO SLOUGHING
OR RAVELING

PLYWOOD SHEETING
REQUIRED
BELOW 10 FT

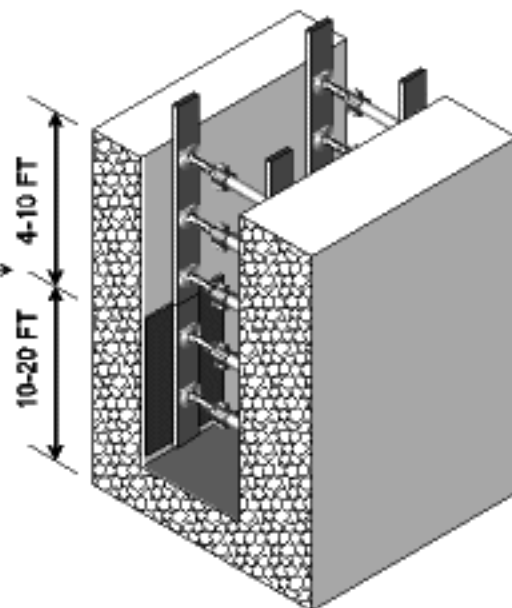

GENERAL REQUIREMENTS

- 1-All *Procedural Requirements* must be followed as specified on page-1.
- 2-All *Component Requirements* must be followed as specified on page-3.
- 3-Horizontal and vertical spacing shall not exceed the maximum allowable spacing specified in *Table-2* below.
- 4-Plywood sheeting is required in all soil classes if sloughing or raveling occurs and is required in class C-60 soils below the 10' depth.
- 5-There shall be a minimum of two columns of shoring in trenches up to 8' in depth. In trenches over 8' in depth, it is recommended that enough columns be placed to protect a length of trench equal to, or greater than the depth of the trench.
- 6-End wall support shall be required as specified on page-6.
- 7-Install pressure shall be 115-220 psi.

TABLE-2: MAXIMUM ALLOWABLE SPACING

SOIL TYPE	TRENCH DEPTH (FT)	TRENCH WIDTH (FT)	HORIZONTAL SPACING (FT)	VERTICAL SPACING (FT)	PLYWOOD SHEETING
A-25	4 to 10	to 6	8	4	*
		6 to 12	8	4	*
		12 to 16	5	4	*
	10 to 15	to 6	8	4	*
		6 to 12	6	4	*
		12 to 16	4	4	*
15 to 20	to 6	6	4	*	
	6 to 12	5	4	*	
	12 to 16	4	4	*	
B-45	4 to 10	to 6	8	4	*
		6 to 12	6	4	*
		12 to 16	4	4	*
	10 to 15	to 6	6	4	*
		6 to 12	4	4	*
		12 to 16	4	4	*
15 to 20	to 6	4	4	*	
	6 to 12	4	4	*	
	12 to 16	4	4	*	
C-60	4 to 10	to 6	6	4	*
		6 to 12	4	4	*
		12 to 16	4	4	*
	10 to 15	to 6	4	4	Required
		6 to 12	4	4	Required
		12 to 16	4	4	Required
15 to 20	to 6	4	4	Required	
	6 to 12	4	4	Required	
	12 to 16	—	—	—	

*Plywood Sheeting is required anytime sloughing or raveling occurs

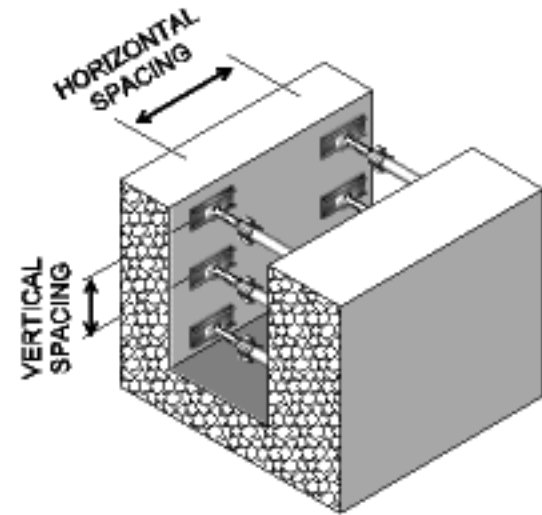

CLASS A & B
NO SLOUGHING
OR
RAVELING

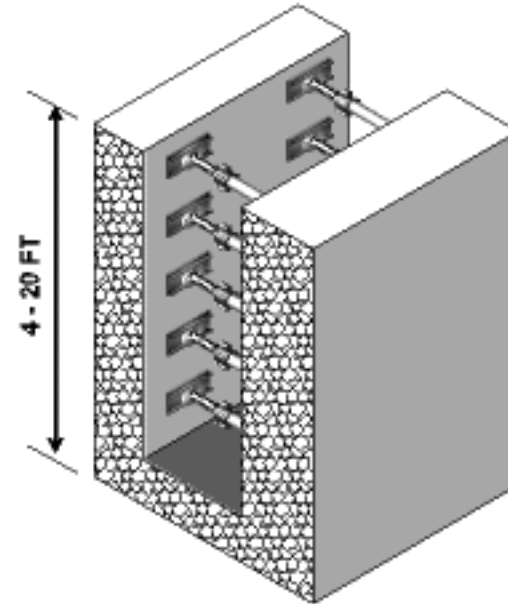

CLASS C-60
NO SLOUGHING
OR RAVELING

PLYWOOD SHEETING
REQUIRED
BELOW 10 FT

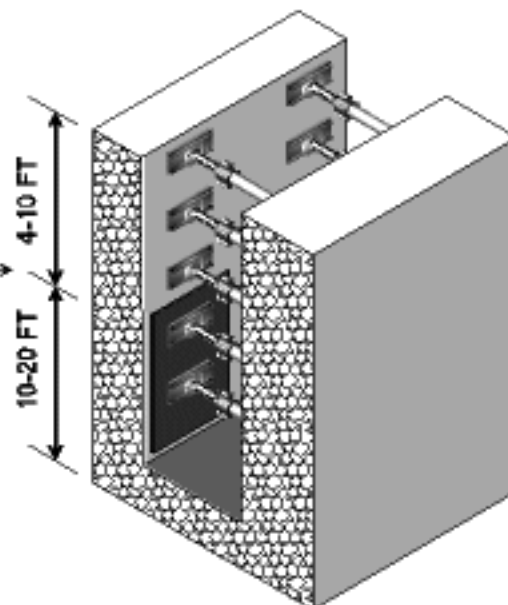

GENERAL REQUIREMENTS

- 1-Vertical trench end-walls must be supported in all cases where workers or their protective system may be struck by a collapsing end-wall.
- 2-If the trench end-wall is sloped-back to the angle allowed for the soil class, as specified in OSHA 29 CFR 1926, Sub-Part P, no additional support is required.
- 3-Trenches with vertical end-walls greater than 6' wide shall be sloped to the acceptable angle, or shored.
- 4-Trenches with vertical end-walls less than 6' wide can be supported by placing a column of shoring within 2' of the end-wall. This column of shoring must meet all requirements of the maximum allowable spacing table.

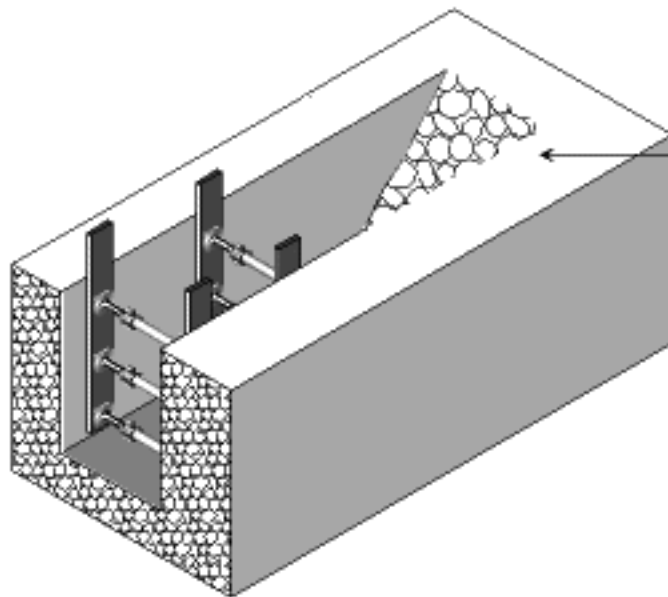

TRENCHES UP TO 15' WIDE

SLOPE ANGLE DETERMINED
BY OSHA 29 CFR 1926 SUB-PART P
FOR SOIL CLASS

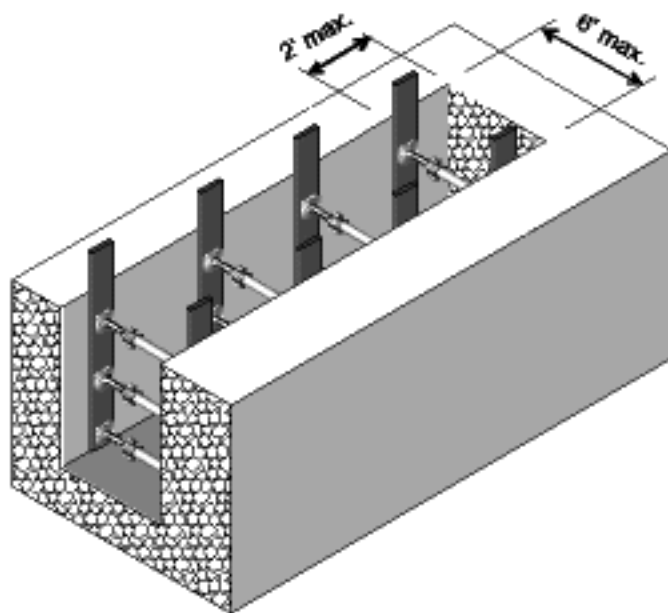

SUPPORT OPTION FOR TRENCHES UP TO 6' WIDE

SHORING MUST MEET ALL REQUIREMENTS
OF PROSPAN TABULATED DATA



GENERAL REQUIREMENTS

- 1-Prospan shoring may be used in conjunction with a trench box to extend the safe zone past the end of the trench box. This option is specifically permitted to allow workers protection when having to deal with crossing utilities/laterals.
- 2-All Prospan shoring elements must be installed in accordance with all provisions of the Prospan Tabulated Data.
- 3-All installation requirements for the trench box must be followed. The trench box shall be rated for the trench dimensions and soil classification and shall be properly positioned in the trench.
- 4-The end of the trench box to be extended must be back-filled between the trench wall and the outside of the trench box for a minimum of 2' from the end of the trench box. The material used for back-filling must be non-compressible and must fill any void space between the trench box and each wall, and must extend the full height of the trench. Acceptable materials may include, but are not limited to; spoil, lumber, stone, etc.
- 5-To extend the protected area, a minimum of one column of Prospan shoring shall be positioned adjacent to the end of the trench box as illustrated below. The spacing between the trench box and the shoring column shall not exceed the allowable horizontal spacing for the trench dimensions and soil class as required by the Prospan Tabulated Data. In trenches deeper than 8', it is recommended that additional columns of shoring be installed to extend the overall safe zone.

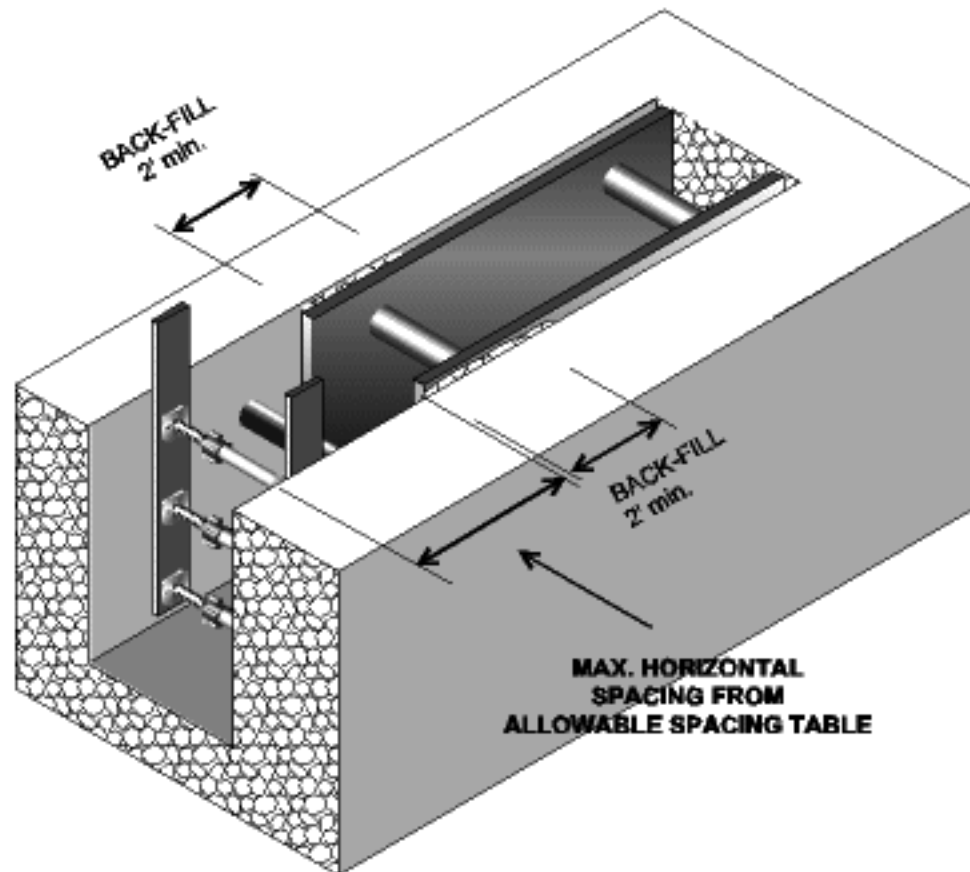

PROSPAN SHORING USED WITH A TRENCH BOX



GENERAL REQUIREMENTS

Intersecting trenches have a high potential for corner failure due to unsupported soil in multiple directions. Whenever possible, corners should be cut back to reduce their potential for failure prior to entry of the trench, and entry to the "corner area" should be avoided. When this is not an option, Prospan struts may be used with 12" Wale Plates or 2" x 12" uprights to support the corners in soils up to class C-60 with the following requirements:

- 1-Corner struts **must** be pressurized simultaneously to limit corner failure. This may be accomplished by attaching air lines from a single regulator to each strut. The struts are then pressurized by slowly increasing regulator pressure from 0 to a minimum install pressure of 120 psi. This process must be repeated for each layer of crossbraces.
- 2-In trenches 10 foot or less in depth, Prospan struts with Wale Plates or uprights may be used directly on the soil without additional wales or sheeting, provided that the corner support struts are placed within 2 feet of the corner and the maximum span between any two columns of shoring on the long wall does not exceed 8 feet.
- 3-In trenches in excess of 10 feet in depth, or in any trench where raveling or sloughing of soil is observed, plywood sheeting must be installed.
- 4-Where trench dimensions result in a span between columns of shoring on the long wall in excess of 8' feet, full-length wales and sheeting must be installed in accordance with OSHA 29 CFR 1926.

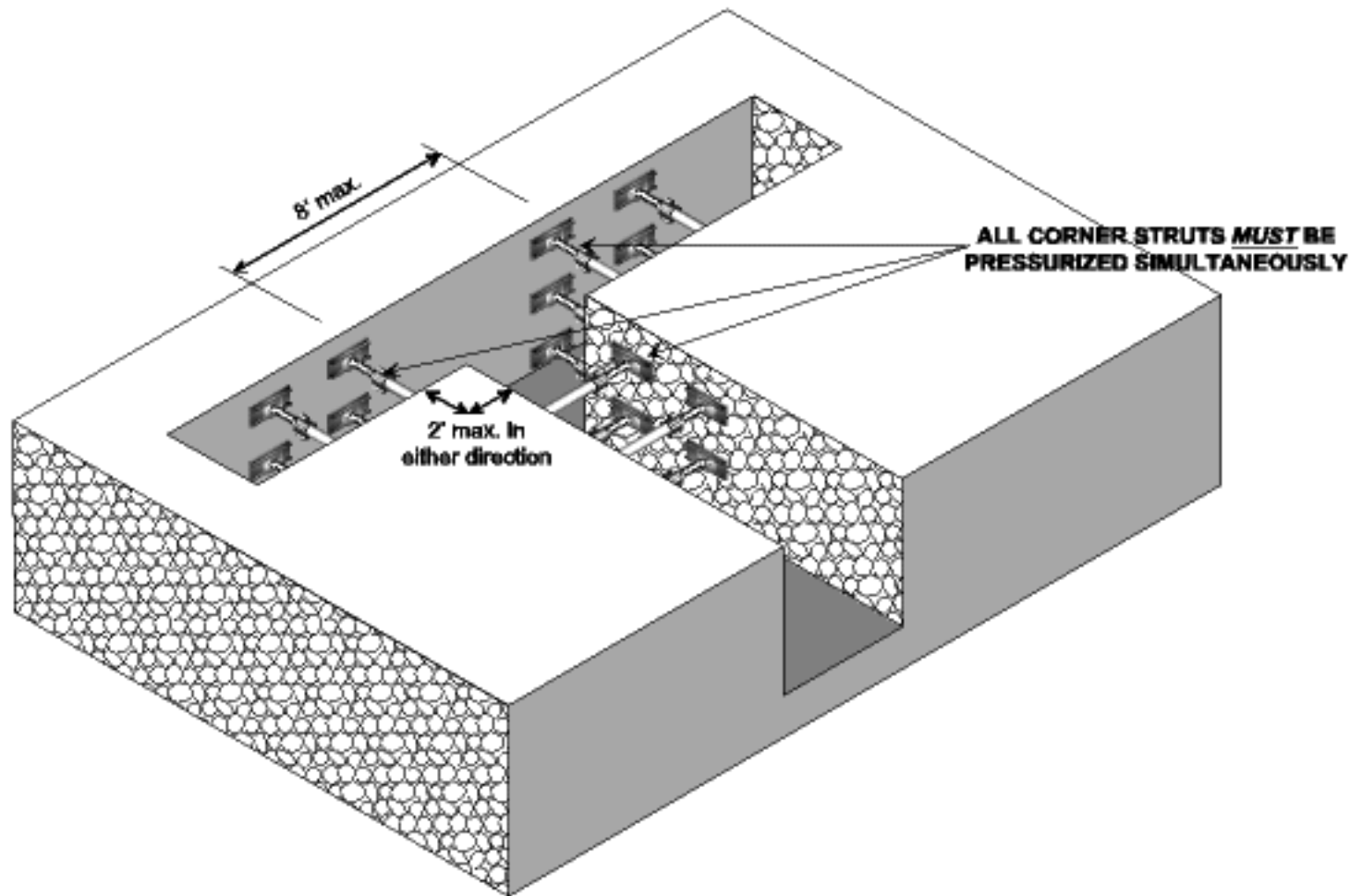

GENERAL REQUIREMENTS

Intersecting trenches have a high potential for corner failure due to unsupported soil in multiple directions. Whenever possible, corners should be cut back to reduce their potential for failure prior to entry of the trench, and entry to the "corner area" should be avoided. When this is not an option, Prospan struts may be used with 12" Wale Plates or 2" x 12" uprights to support the corners in soils up to class C-60 with the following requirements:

- 1-Corner struts **must** be pressurized simultaneously to limit corner failure. This may be accomplished by attaching air lines from a single regulator to each strut. The struts are then pressurized by slowly increasing regulator pressure from 0 to a minimum install pressure of 120 psi. This process must be repeated for each layer of crossbraces.
- 2-In trenches 10 foot or less in depth, Prospan struts with Wale Plates or uprights may be used directly on the soil without additional wales or sheeting, provided that the corner support struts are placed within 2 feet of the corner and the maximum span between any columns of shoring and the outside corner does not exceed 6 feet
- 3-In trenches in excess of 10 feet in depth, or in any trench where raveling or sloughing of soil is observed, plywood sheeting must be installed.
- 4-Where trench dimensions result in a span between a column of shoring and the outside corner exceeds 6 feet, additional shoring elements must be installed in accordance with OSHA 29CFR 1926

